

Madison 40 (520x400)

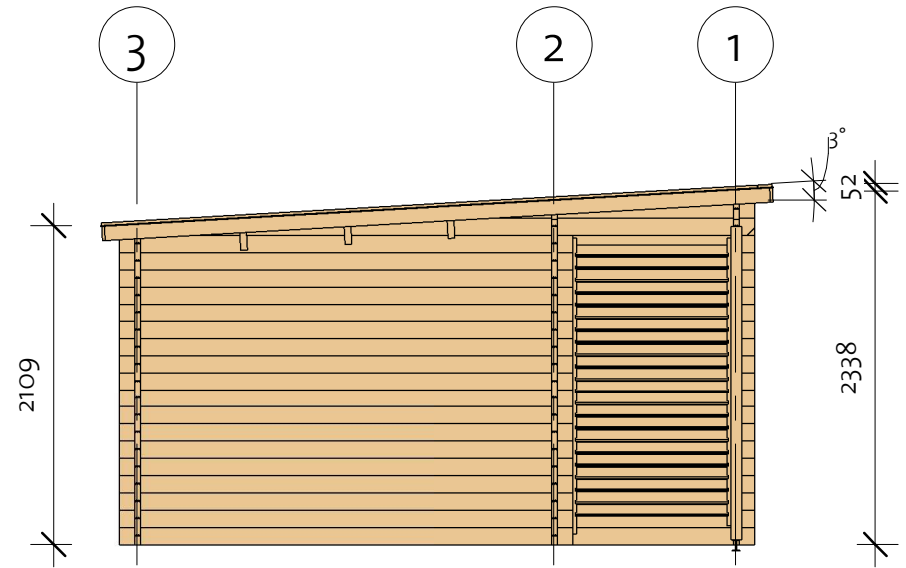

Madison 40 (520x400)

Floor Plan

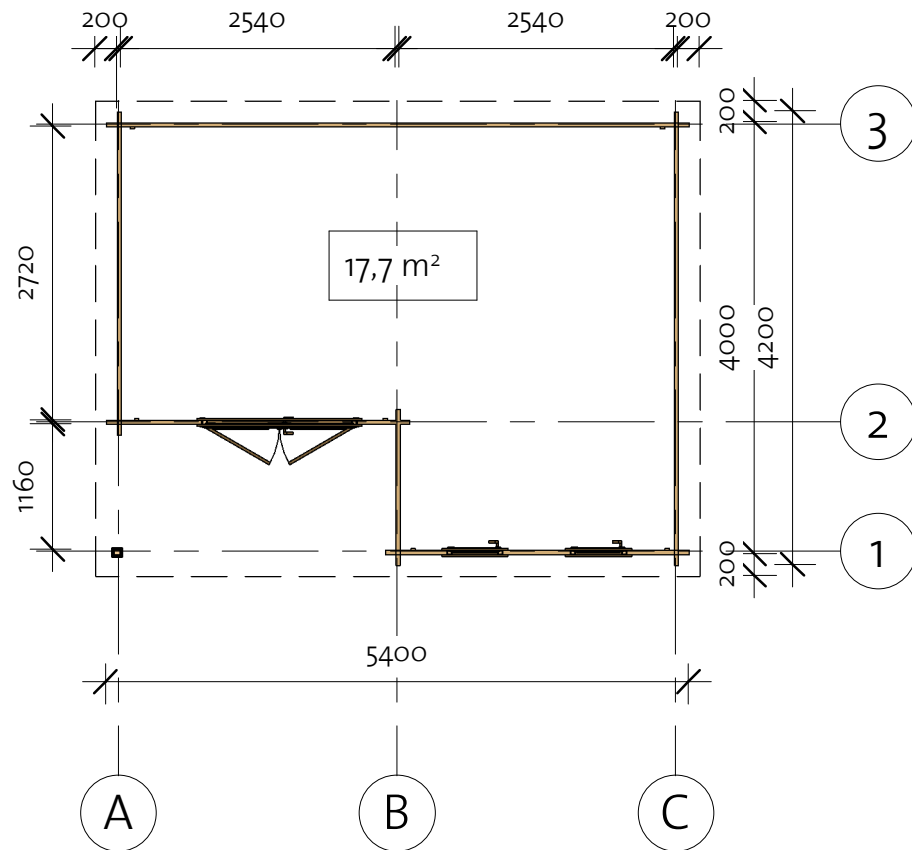
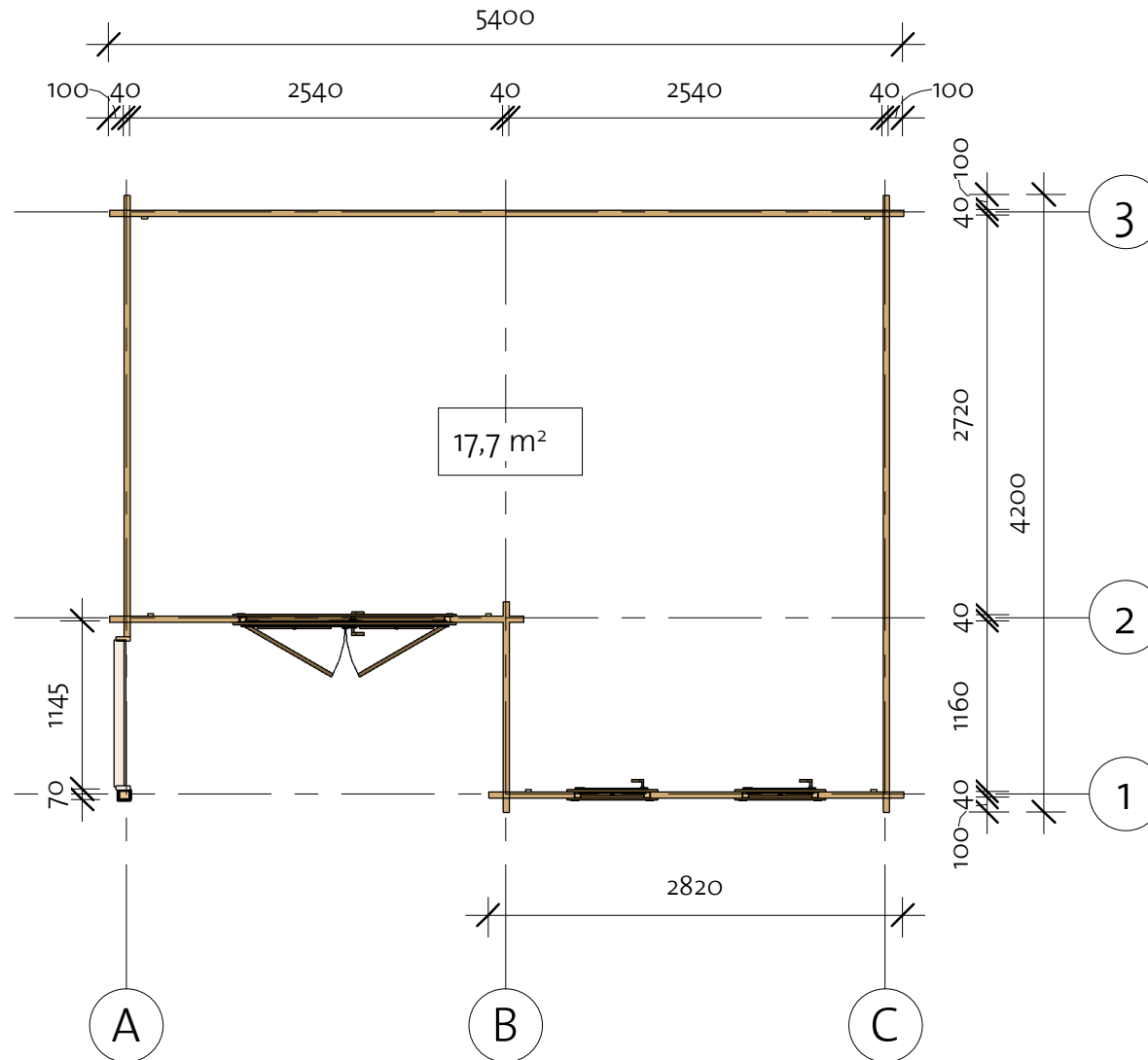

Madison 40 (520x400)

Wall 1

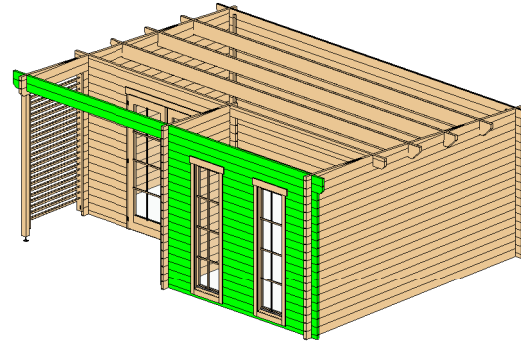

Wall 1			
Mark	Profile	Count	Cut Length

1BL-1	40x57	1	2820
1LG-1	40x114	1	5600
1LG-2	40x114	34	580
1LG-3	40x114	1	2820
1LG-4	40x114	17	620
1TL-1	40x114	1	5600

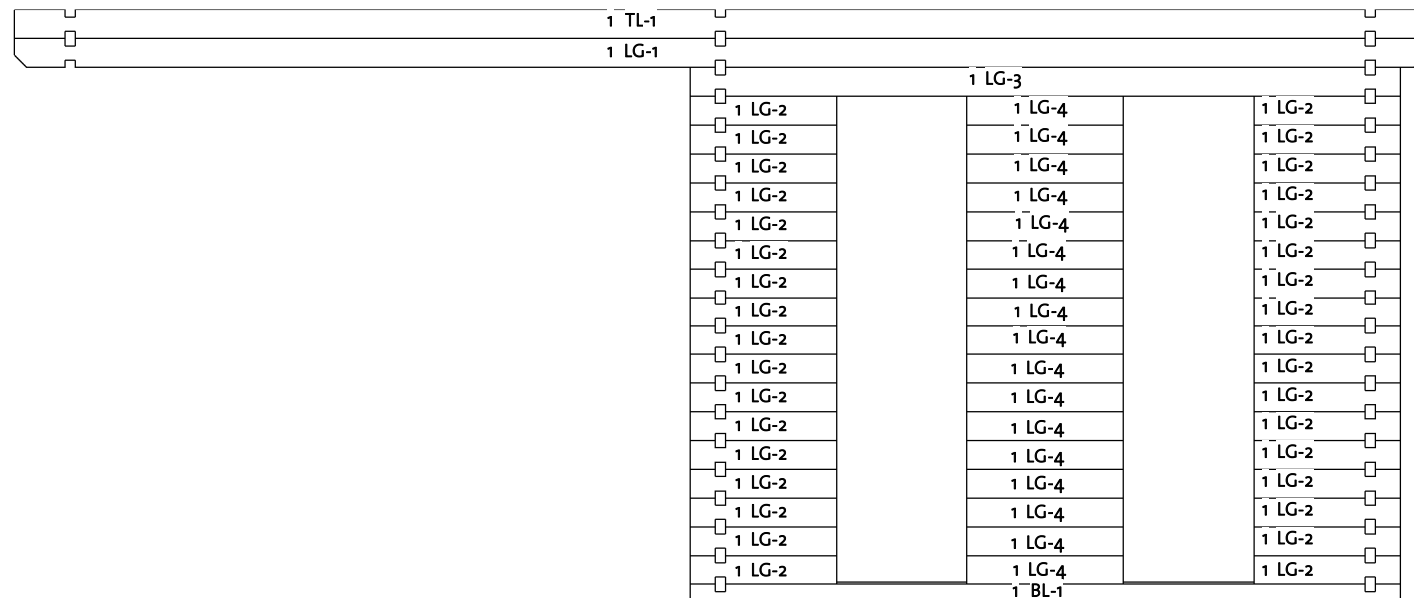

2680

580

520

620

520

580

100

Log Profile Wall 1	
Profile	Profile

40x57	
40x114	
40x114	

Madison 40 (520x400)

Wall 2

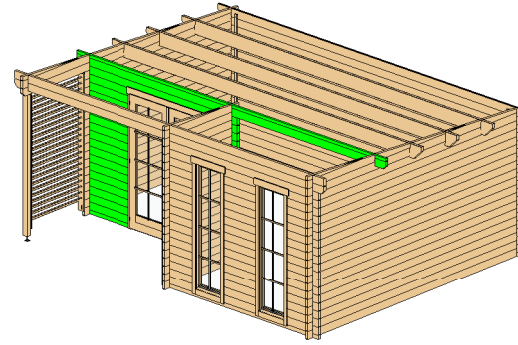

Wall 2			
Mark	Profile	Count	Cut Length

2BL-1	40x57	1	880
2BL-2	40x57	1	500
2LG-1	40x114	1	5600
2LG-2	40x114	1	2820
2LG-3	40x114	17	500
2LG-4	40x114	17	880
2TL-1	40x45	1	5600

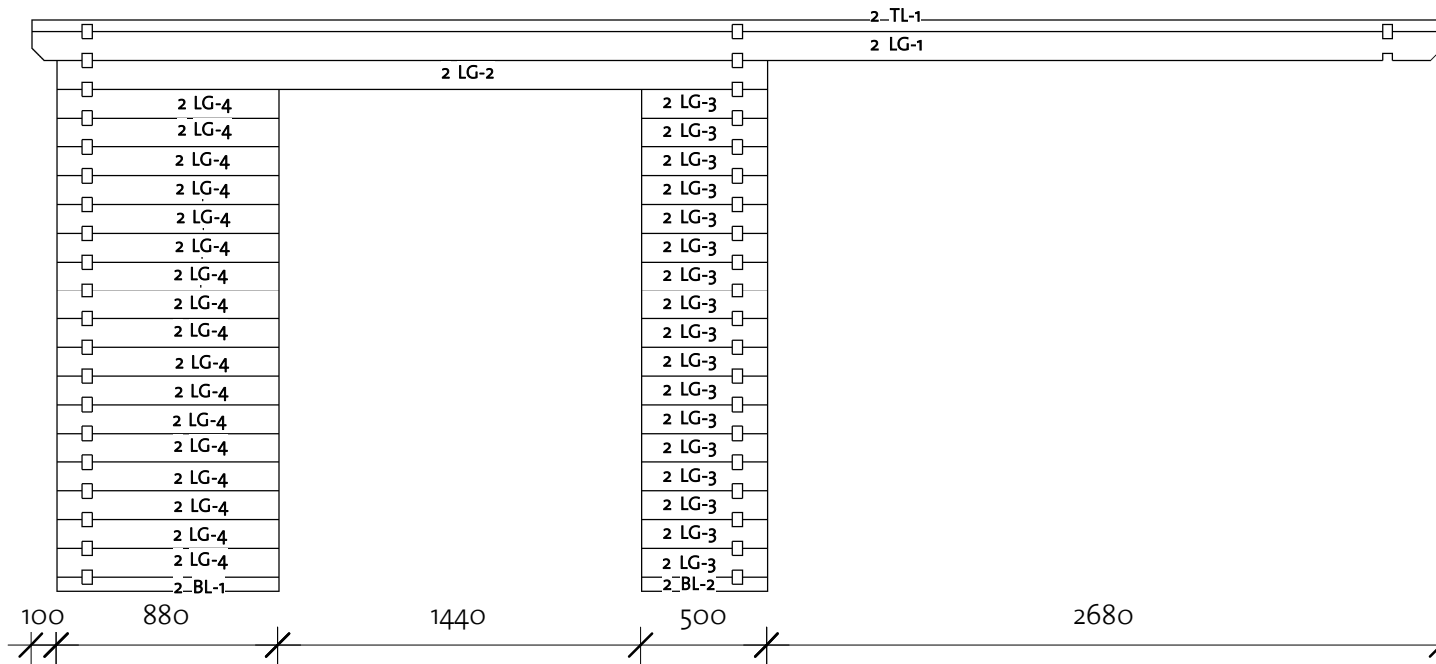

Log Profile Wall 2	
Profile	Profile

40x45	
40x57	
40x114	

Madison 40 (520x400)

Wall 3

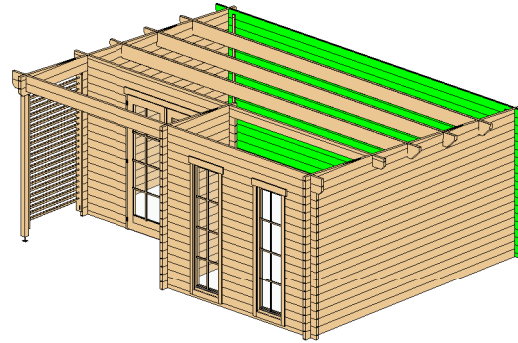

Wall 3			
Mark	Profile	Count	Cut Length

3BL-1	40x57	1	5400
3LG-1	40x114	17	5400
3TL-1	40x114	1	5600

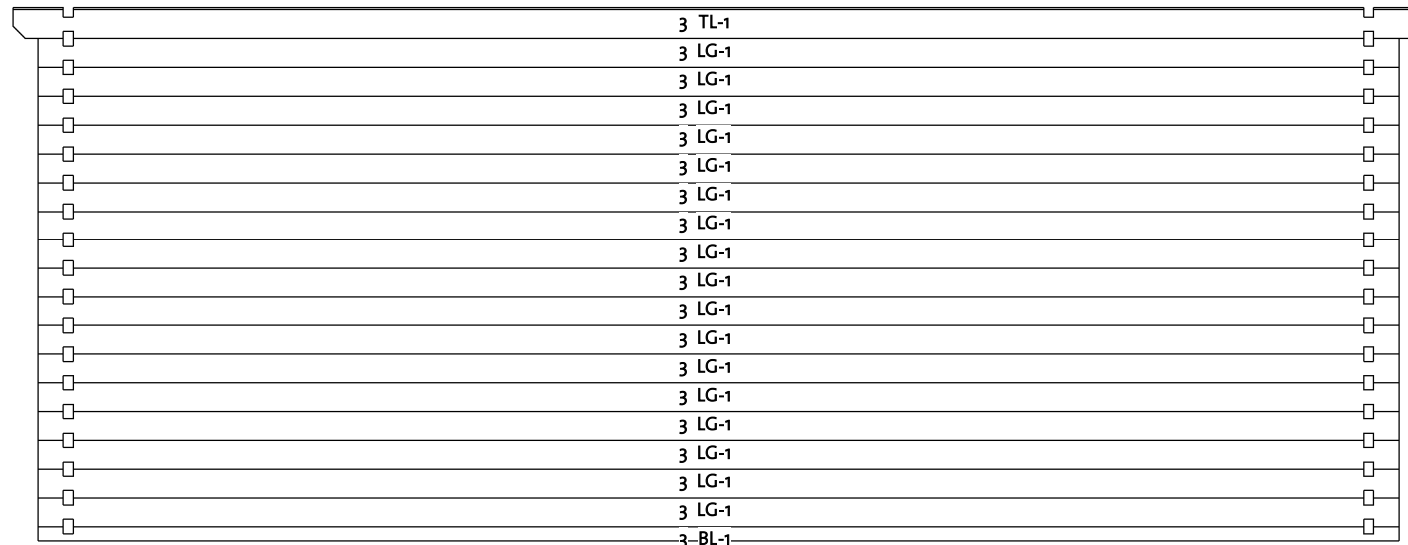

Log Profile Wall 3	
Profile	Profile

40x57	
40x114	
40x114	

100
//

5400

100
//

Madison 40 (520x400)

Wall A

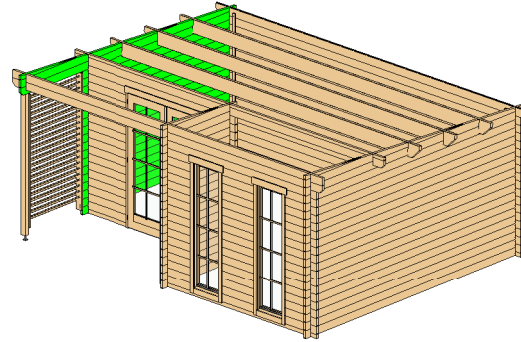

Wall A			
Mark	Profile	Count	Cut Length

ALG-1*	40X114	1	1090
ALG-2*	40X114	1	3070
ALG-3*	40X114	1	4200
ALG-4*	40X114	1	3000
ALG-5	40X114	17	3000

* Gable - delivered premounted

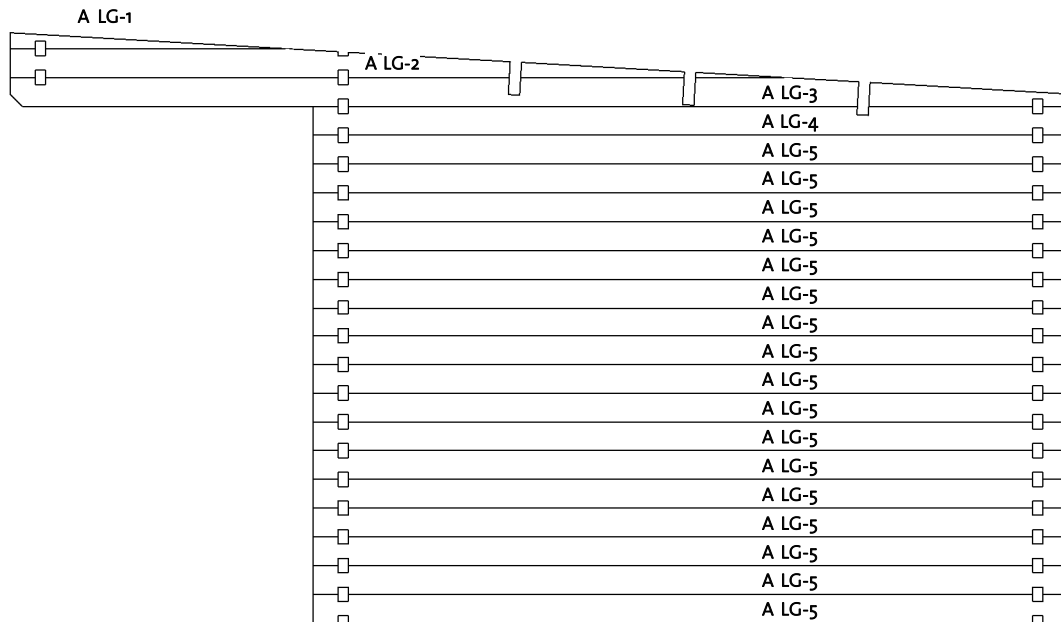

919080713_230717

Log Profile Wall A	
Profile	Profile

40X114	
--------	--

Madison 40 (520x400)

Wall C

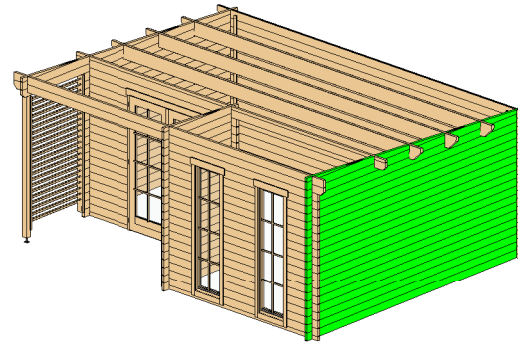

Wall C			
Mark	Profile	Count	Cut Length

CLG-1*	40X114	1	1090
CLG-2*	40X114	1	3070
CLG-3*	40X114	1	4200
CLG-4*	40X114	1	4200
CLG-5	40X114	17	4200

* Gable - delivered premounted

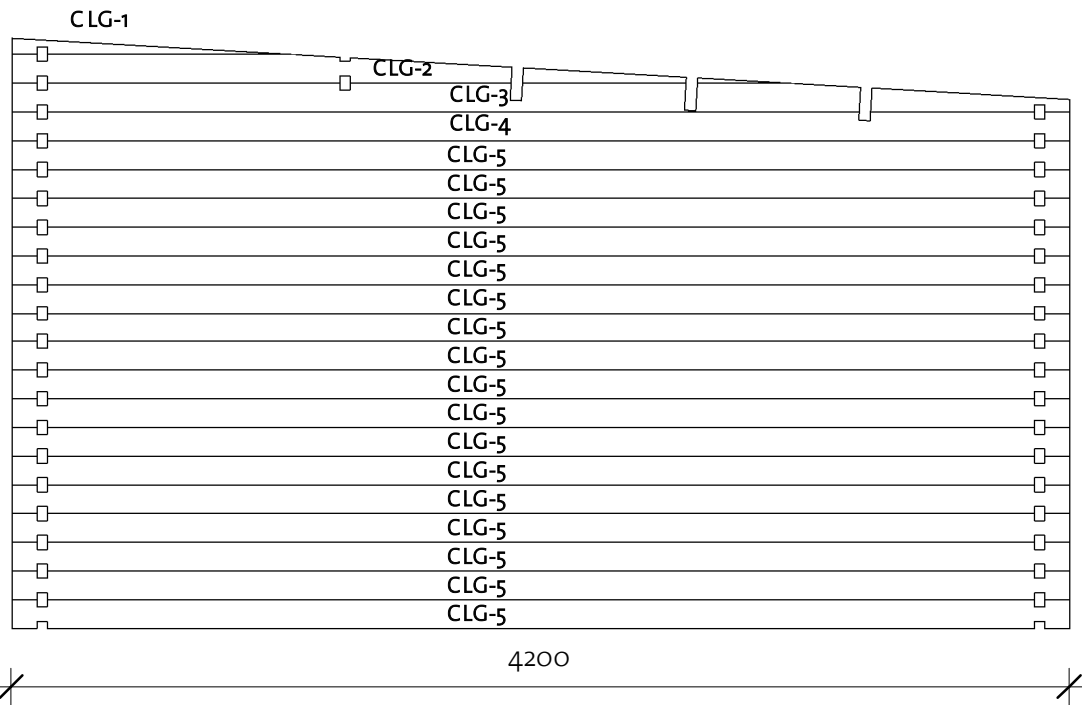

Log Profile Wall C	
Profile	Profile

40X114	
--------	--



919080713_230717

Madison 40 (520x400)

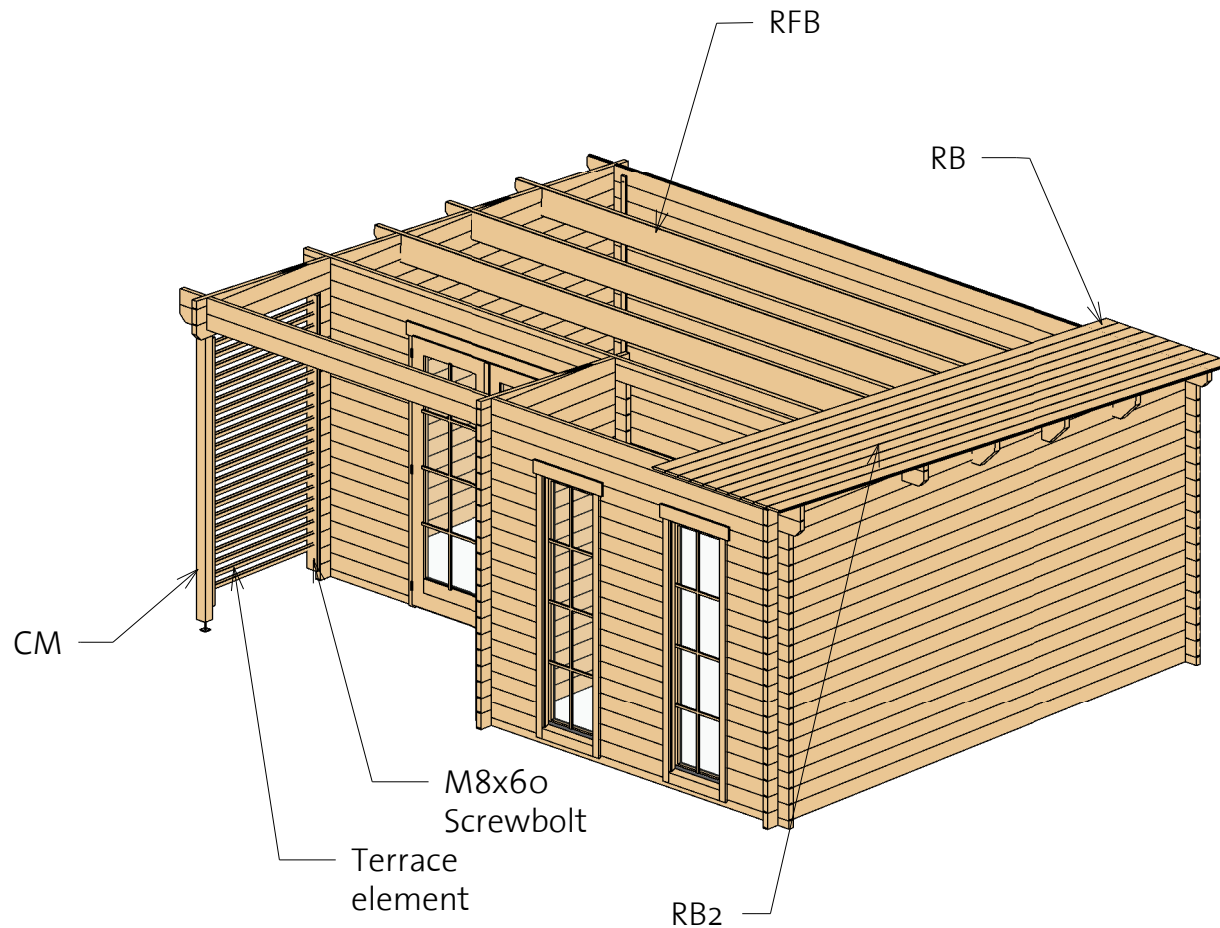
Roof 1



Roof				
Mark	Type	Profile	Count	Length

RB	17x114		50	4406
RFB	Beam 45x195		3	5600

Terrace element			
Mark	Type	Count	Length

TS1	28x95	1	1906
TS2	28x95	1	1960
TS3	18x95	22	1009

Columns			
Mark	Profile	Count	Length

CM	Post 80x70	1	2074
----	------------	---	------

919080713_230717

Madison 40 (520x400)

Roof 2

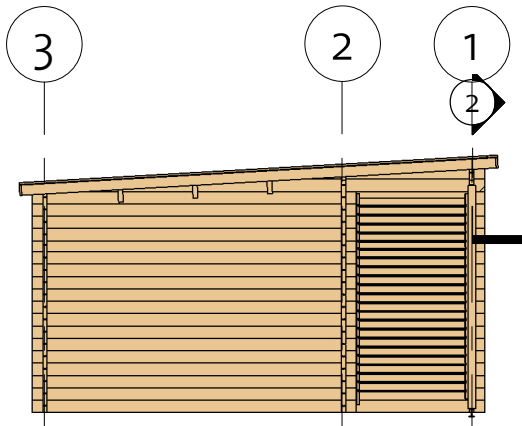

② Facia

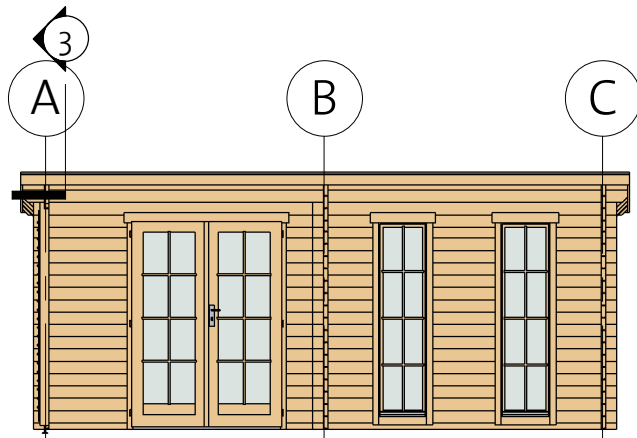
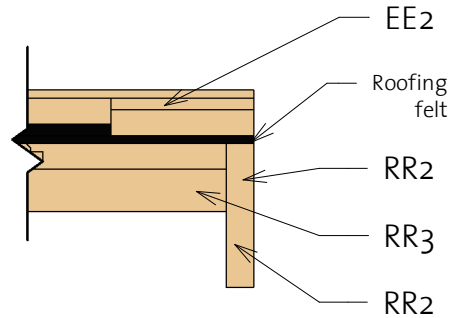

③ Roof Reinforcement

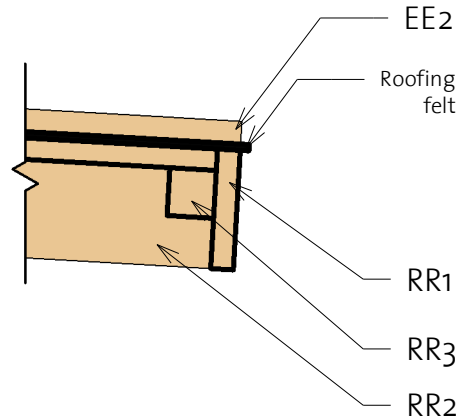

Fascia Schedule

Mark	Type	Profile	Count	Length
EE1	Eave Edging 18x95		1	5636
EE2	Eave Edging 18x95		2	4345
RR1	Roof reinforcement 18x95		2	5636
RR2	Roof reinforcement 18x95		2	4406
RR3	Roof reinforcement 38x38		2	5600

Madison 40 (520x400)

Extras

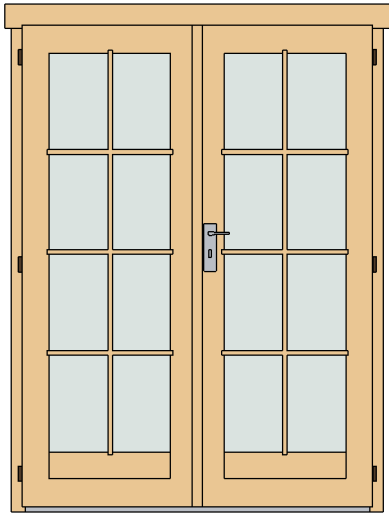

Door Schedule				
Model	Type	Width	Height	Count
CDD3R	Classic double door 3 right	1425	1955	1
DCB8	Door Crossbar 8	--	--	2

Type	Count
Windboard 18x40x2200	6



Fasteners/Extras		
Name	Type	Count

Hitblock	300-400 mm	
Adjustable post foot		1
Screwbolt	M8 x 60	1
Bolts	M8x70	18
Screws	5,0 x 70	25
Screws	6,0 x 140	35
Screws	4,0 x 40	410

Window Schedule				
Mark	Type	Width	Height	Count
CW21R	Classic window 21 right	515	1890	2
WCB8	Windows Crossbar 8	--	--	2

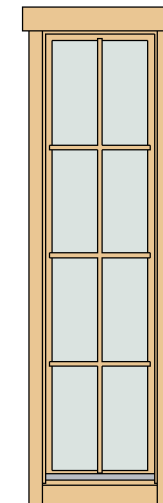

- * Windows intended for tilt opening only!
- * Fenster zur Eröffnung nur zum Kippen vorgesehen!
- * Aknad on ette nähtud ainult kaldu avamiseks!

Madison 40 (520x400)

List of all items 1



Columns			
Mark	Profile	Count	Length

CM	Post 80x70	1	2074
----	------------	---	------





Terrace element			
Mark	Type	Count	Length

TS1	28x95	1	1906
TS2	28x95	1	1960
TS3	18x95	22	1009

Roof				
Mark	Type	Profile	Count	Length

RB	17x114		50	4406
RFB	Beam 45x195		3	5600

Fascia Schedule				
Mark	Type	Profile	Count	Length

EE1	Eave Edging 18x95		1	5636
EE2	Eave Edging 18x95		2	4345
RR1	Roof reinforce ment 18x95		2	5636
RR2	Roof reinforce ment 18x95		2	4406
RR3	Roof reinforce ment 38x38		2	5600

Madison 40 (520x400)

List of all items 2

Wall 1			
Mark	Profile	Count	Cut Length

1BL-1	40x57	1	2820
1LG-1	40x114	1	5600
1LG-2	40x114	34	580
1LG-3	40x114	1	2820
1LG-4	40x114	17	620
1TL-1	40x114	1	5600

Wall 3			
Mark	Profile	Count	Cut Length

3BL-1	40x57	1	5400
3LG-1	40x114	17	5400
3TL-1	40x114	1	5600

Wall A			
Mark	Profile	Count	Cut Length

ALG-1*	40x114	1	1090
ALG-2*	40x114	1	3070
ALG-3*	40x114	1	4200
ALG-4*	40x114	1	3000
ALG-5	40x114	17	3000

Wall B			
Mark	Profile	Count	Cut Length

BLG-1*	40x114	1	1090
BLG-2*	40x114	1	1440
BLG-3	40x114	19	1440

Wall 2			
Mark	Profile	Count	Cut Length

2BL-1	40x57	1	880
2BL-2	40x57	1	500
2LG-1	40x114	1	5600
2LG-2	40x114	1	2820
2LG-3	40x114	17	500
2LG-4	40x114	17	880
2TL-1	40x45	1	5600



Wall C			
Mark	Profile	Count	Cut Length

CLG-1*	40x114	1	1090
CLG-2*	40x114	1	3070
CLG-3*	40x114	1	4200
CLG-4*	40x114	1	4200
CLG-5	40x114	17	4200

* Gable - delivered premounted

Log profiles	
Profile	Profile

Log profiles	
Profile	Profile

40x57	
40x45	

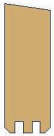
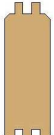
40x114	
40x114	

Windboard

① Windboard Assembly 1



② Windboard Assembly 2

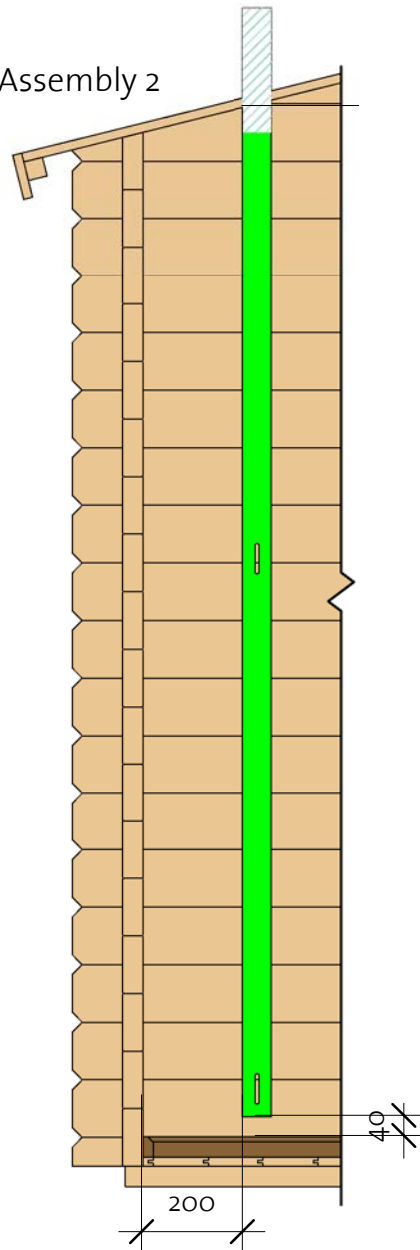

③ Windboard Assembly 3

